

808 Camera Template - 4in (98mm)

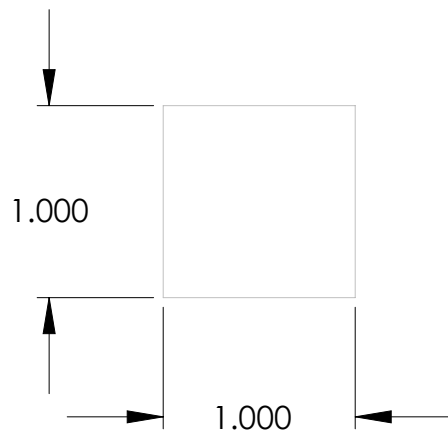
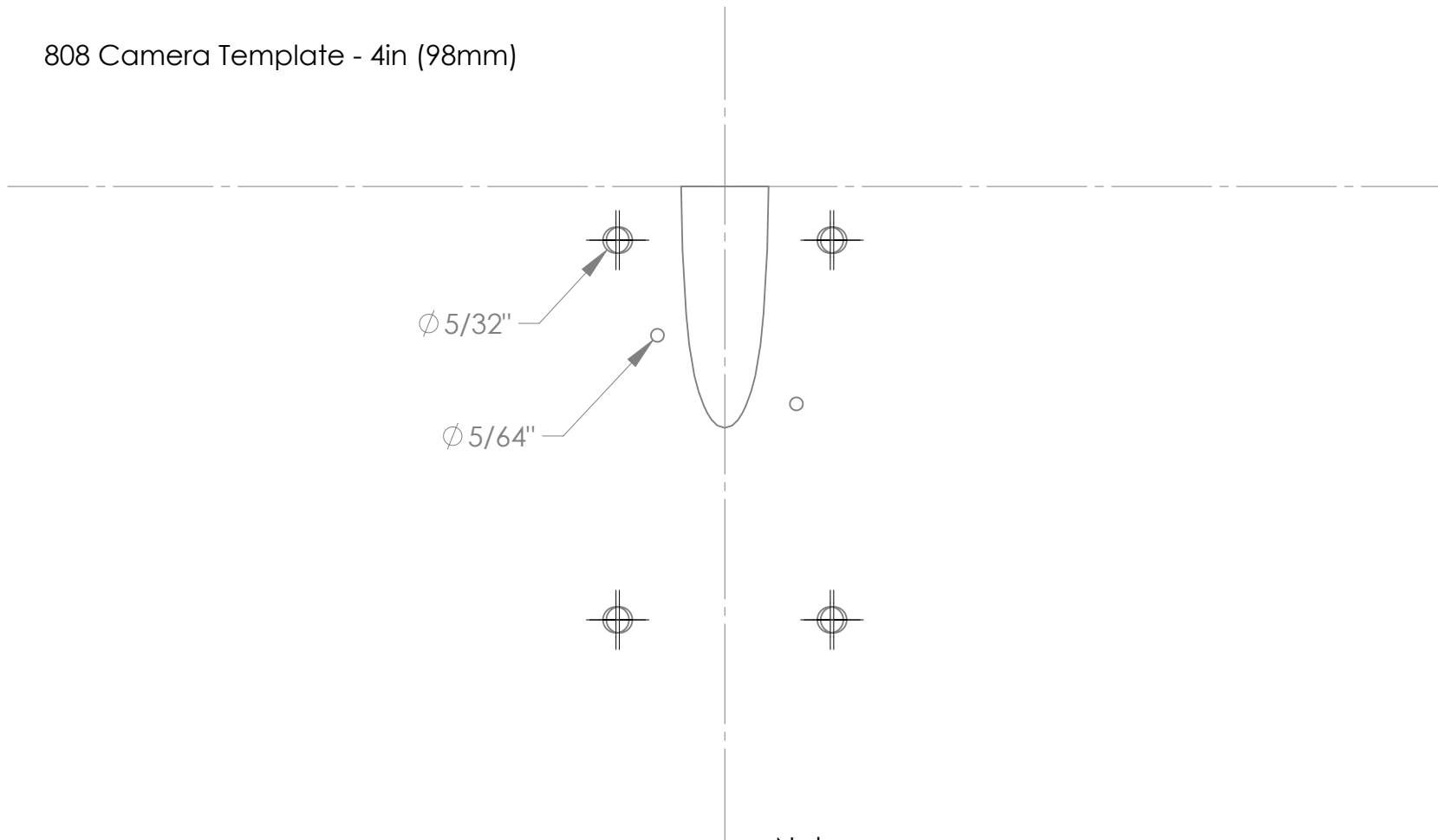

Notes:

- 1) See the installation instructions for detailed instructions.
- 2) Print using "actual size" setting and verify the 1 inch square is correctly sized in both directions.
- 3) Mounting holes are drilled perpendicular to the tube wall at their locations. Route and access holes should be made parallel to the shroud center plane.
- 4) The further spaced mounting holes are for 1/8" thick wall, the inner set is for 1/16" thick wall. Measure your actual wall and adjust your mounting holes accordingly.
- 5) For open carriers only drill the two mounting holes near the shroud. For sealed carriers drill all four.